

Technical data
Hydraulic lift crane

LR 1200
Litronic®

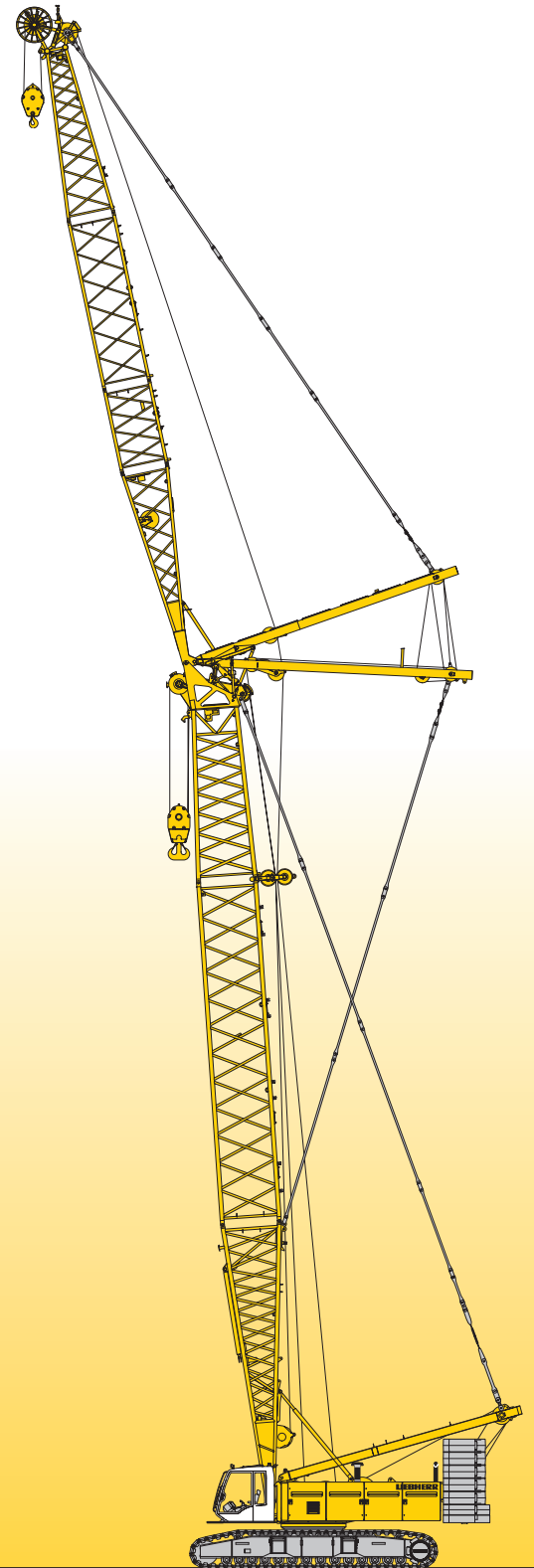

LIEBHERR

Dimensions

Basic machine with undercarriage

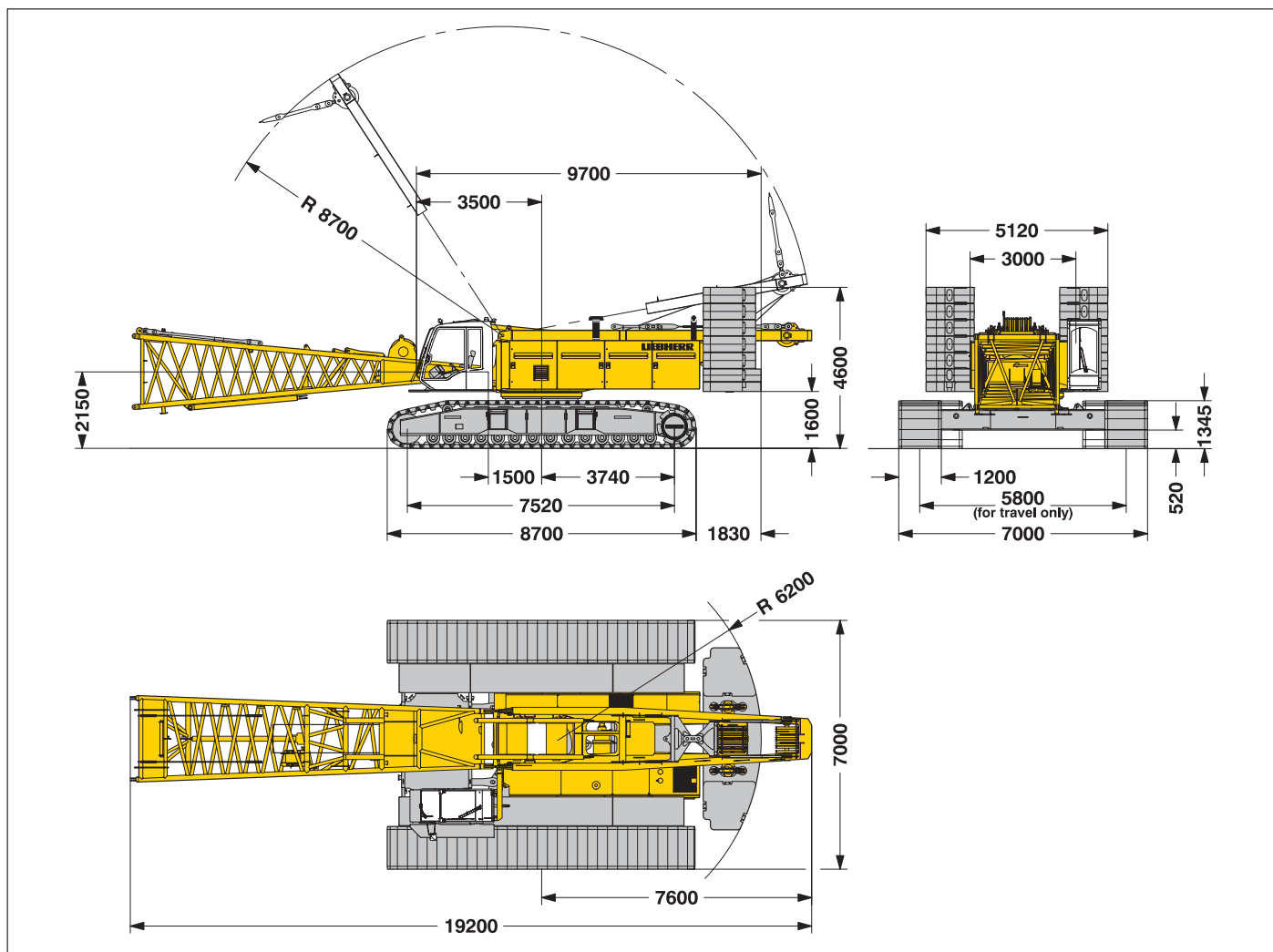

Operating weight

The operating weight includes the basic machine with crawlers, 2 main winches 120 kN including wire ropes (260 m and 495 m) and 20 m main boom, consisting of A-frame, boom foot (10 m), boom head (7 m), boom extension (3 m), 81 t basic counterweight, 36 t carbody counterweight and 250 t hook block.

Total weight _____ approx. 210.0 t

Ground pressure

Ground bearing pressure _____ 1.16 kg/cm²

Equipment

Main boom (No. 2320.xx) max. length _____ 89 m
 High reach (No. 2320.xx and 1916.xx) _____ 117 m
 Luffing jib (No. 1916.xx) max. length _____ 95 m
 Max. combination _____ boom 53 m and luffing jib 95 m
 Fixed jib (No. 1008.xx) _____ 11 m – 26 m
 Auxiliary jib 24 t lifting capacity (Optional 36 t)

Remarks

1. The lifting capacities stated are valid for lifting operation only (corresponds with crane classification according to F.E.M. 1.001, crane group A1).
2. Crane standing on firm, horizontal ground.
3. The weight of the lifting device (hoisting ropes, hook block, shackle etc.) must be deducted from the gross lifting capacity to obtain a net lifting value.
4. Additional equipment on boom (e.g. boom walkways, auxiliary jib) must be deducted to get the net lifting capacity.
5. For max. wind speed please refer to lift chart in operator's cab or manual.
6. Working radii are measured from centre of swing and under load.
7. The lifting capacities are valid for 360 degrees of swing.
8. Calculation of stability under load is based on DIN 15019 / part 2 / chart 1 and ISO 4305 Table 1 + 2, tipping angle 4°.
9. The structures are calculated according to F.E.M. 1.001 – 1998 (EN 13001–2 / 2004).

Transport dimensions and weights

Basic machine and boom (No. 2320.xx)

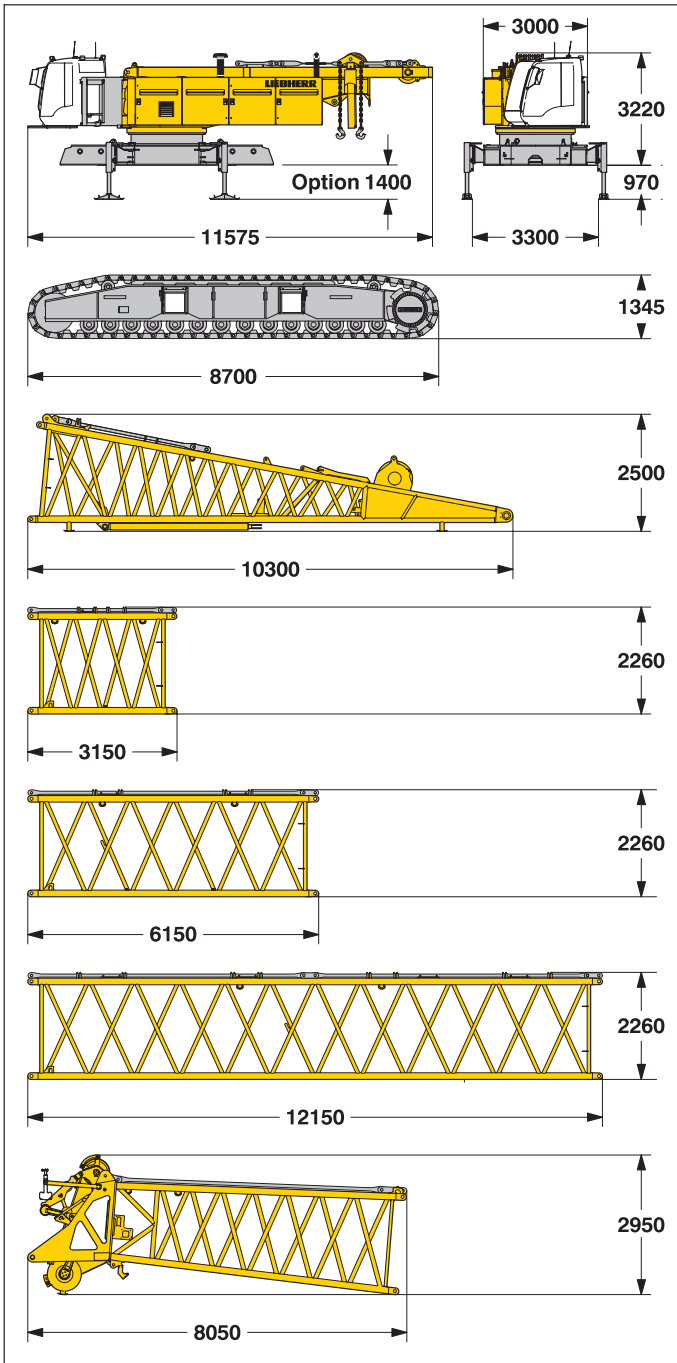

Basic machine

with A-frame, 2x 120 kN crane winches including wire ropes (total hoist ropes 755 m), without crawlers, boom foot, basic counterweight and carbody counterweight

Width	mm	3000
Weight	kg	40800

Crawler

2x

Flat track shoes	mm	1200
Width	mm	1200
Weight	kg	19800

Boom foot (No. 2320.25)

Width	mm	2430
Weight incl. winch and rope	kg	5600
Weight without winch	kg	4000

Boom section (No. 2320.23)

3 m

Width	mm	2430
Weight*	kg	925

Boom section (No. 2320.20)

6 m

Width	mm	2430
Weight*	kg	1285

Boom section (No. 2320.20)

12 m

Width	mm	2430
Weight*	kg	2360

Boom head (No. 2320.23)

Width	mm	2430
Weight*	kg	4300

Transport option

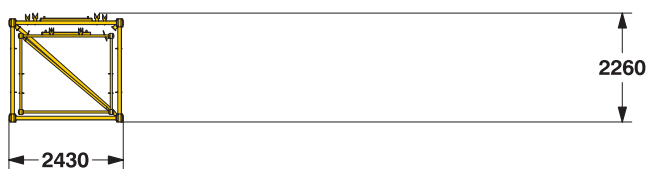

Boom transport option

No. 2320.xx/1916.xxx	m	12 / 12	6 / 6	3 / 3
Length	mm	12250	6250	3250
Weight*	kg	3610	1975	1475

*) Including pendant straps

Transport dimensions and weights

Luffing jib (No. 1916.xx)

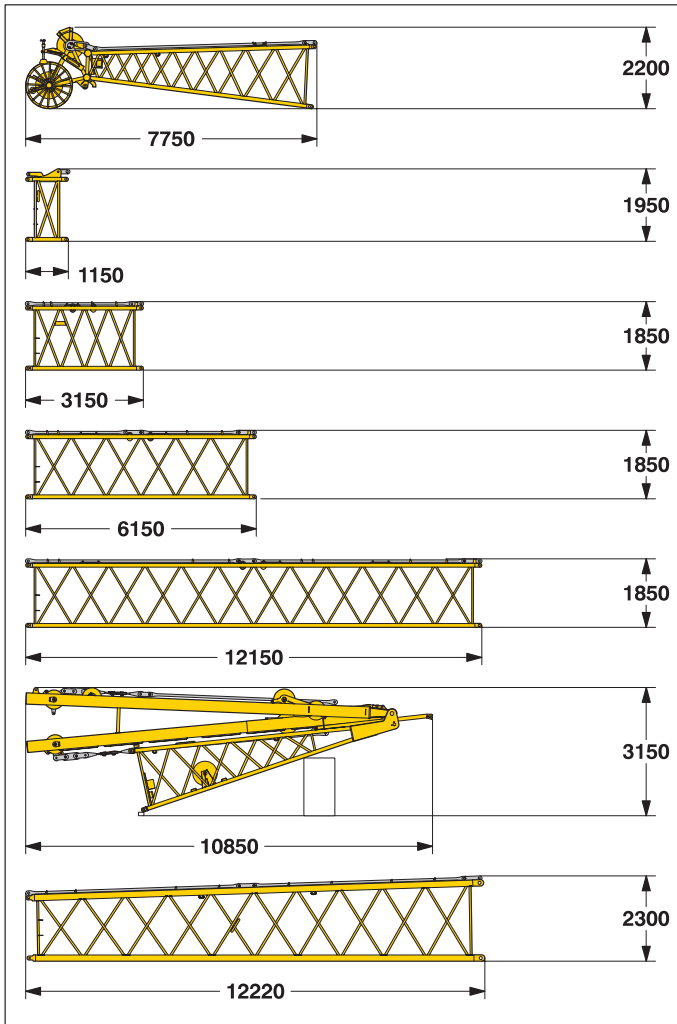

Luffing jib head (No. 1916.21)

Width	mm	2010
Weight*	kg	1550

L - boom jib section (No. 1916.22) **1 m**

Width	mm	2010
Weight*	kg	460

Luffing jib section (No. 1916.18) **3 m**

Width	mm	2010
Weight*	kg	475

Luffing jib section (No. 1916.18) **6 m**

Width	mm	2010
Weight*	kg	690

Luffing jib section (No. 1916.18) **12 m**

Width	mm	2010
Weight*	kg	1250

Luffing jib foot with A-frames (No. 1916.22)

Width	mm	2010
Weight*	kg	6300

L - boom section tapered (No. 2320/1916.20) **12 m**

Width	mm	2430
Weight*	kg	1700

Fixed jib (No. 1008.xx)

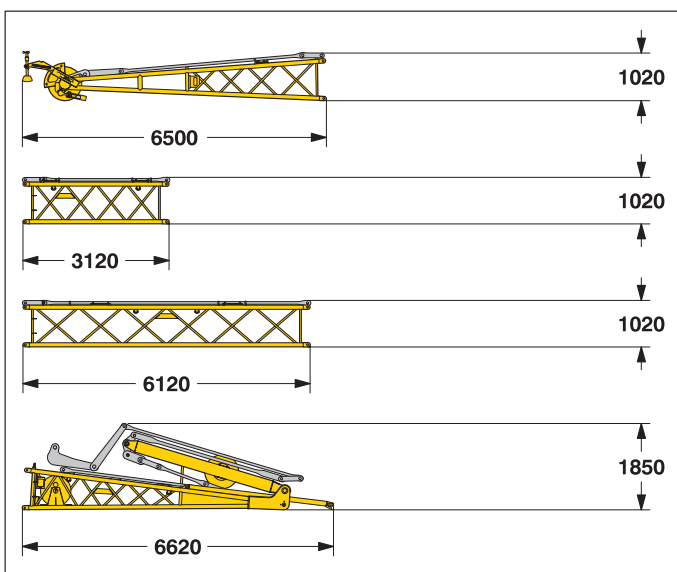

Fixed jib head (No. 1008.20)

Width	mm	1090
Weight*	kg	920

Fixed jib section (No. 1008.17) **3 m**

Width	mm	1090
Weight*	kg	300

Fixed jib section (No. 1008.17) **6 m**

Width	mm	1090
Weight*	kg	455

Fixed jib foot with A-frame (No. 1008.20)

Width	mm	2200
Weight*	kg	1950

*) Including pendant straps

Transport dimensions and weights

Counterweights

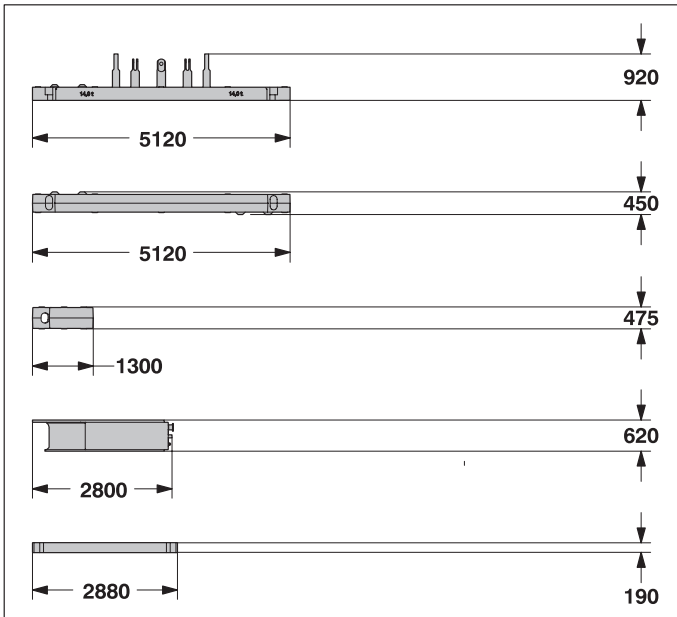

Counterweight **1x**

Width	mm	1660
Weight	kg	14500

Counterweight **1x**

Width	mm	1660
Weight	kg	16300

Counterweight **10x**

Width	mm	1360
Weight	kg	5100

Carbody counterweight **2x**

Width	mm	3340
Weight	kg	9800

Carbody counterweight **2x**

Width	mm	2050
Weight	kg	8300

Mid fall (option)

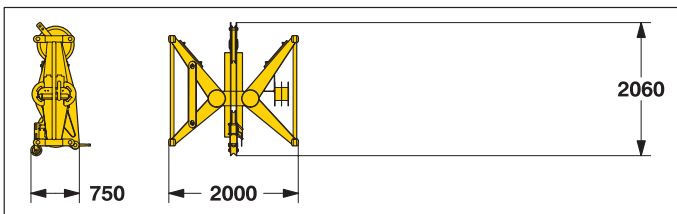

Mid fall section (No. 1916.32) **0.5 m**

Width	mm	750
Weight	kg	715

Hooks

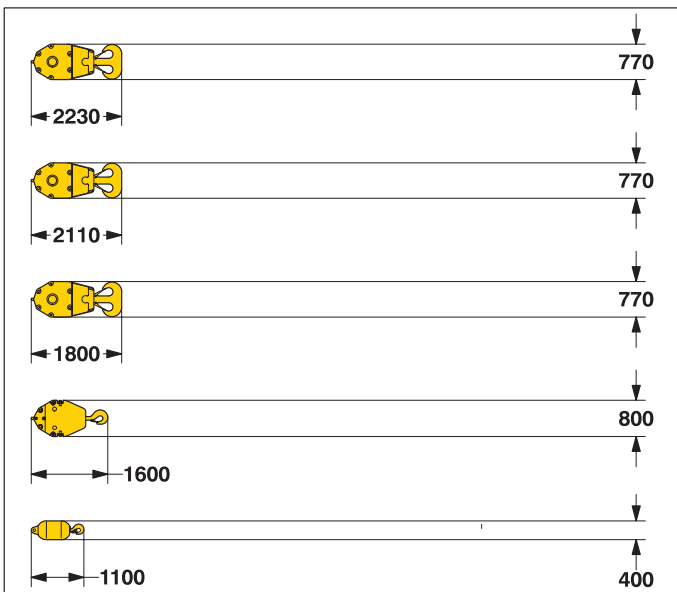

250 t hook block - 11 sheaves

Width	mm	1030 — 1250
Weight	kg	2300 — 3200

160 t hook block - 7 sheaves

Width	mm	640 — 760 — 880
Weight	kg	1500 — 2250 — 3000

100 t hook block - 5 sheaves

Width	mm	540 — 640 — 770
Weight	kg	1300 — 1800 — 2300

40 t hook block - 1 sheave

Width	mm	300 — 400 — 500
Weight	kg	700 — 1100 — 1500

12.5 t single hook

Width	mm	400
Weight	kg	600

Technical description



Engine

Power rating according to ISO 9249, 270 kW (362 hp) at 2000 rpm
Engine type ———— Liebherr D 936 L A6
Fuel tank ———— 800 l capacity with continuous level indicator and reserve warning

Engine complies with NRMM exhaust certification EPA / CARB Tier 3 and 97/68 EC Stage III



Hydraulic system

A double axial displacement pump supplies the open loop hydraulic system, allowing all functions to be operated simultaneously. To minimize peak pressure an automatic working pressure cut-off is integrated in the pump. All filters are electronically monitored.

The use of synthetic environmentally friendly (biodegradable) oils is possible.

Working pressure ———— max. 350 bar

Oil tank capacity ———— 650 l



Luffing jib winch

Line pull ———— max. 105 kN

Rope diameter ———— 20 mm

Jib luffing ———— 51 sec. from 15° to 78°



Boom winch

Line pull ———— max. 217 kN

Rope diameter ———— 24 mm

Boom up ———— 130 sec. from 15° to 86°



Swing

Consists of rollerbearing with external teeth, swing drive with fixed axial piston hydraulic motor, spring loaded and hydraulically released multi-disc holding brake, planetary gearbox and pinion.

Both swing modes are possible – speed control or free swing.

A multi-disc holding brake acts automatically at zero swing motion.

Swing speed from 0 – 3 rpm continuously variable.



Main winches

Line pull (1st layer) ———— max. 175 kN

Line pull (7th layer) ———— 120 kN

Rope diameter ———— 26 mm

Drum diameter ———— 580 mm

Rope speed m/min ———— 0 – 136

Rope capacity in 7 layers ———— 489 m

The winches are outstanding in their compact design and easy assembly. Propulsion is via a planetary gearbox in an oil bath.

Load support by the hydraulic system; additional safety factor provided by a spring loaded, multi-disc holding brake.

The main winches use pressure controlled, variable flow hydraulic motors.

This system features sensors that automatically adjust oil flow to provide max. winch speed depending on load.

Option – winch with freefall system:

Clutch and braking functions on the freefall system are provided by a compact designed, low wear and maintenance free multi-disc brake.



Crawlers

Propulsion through axial piston motor, hydraulically released spring loaded multi-disc brake, crawler tracks, hydraulic chain tensioning device.

Flat track shoes ———— 1200 mm

Drive speed ———— 0 – 1.6 km/h



Control

The control system – developed and manufactured by Liebherr – is designed to withstand extreme environmental conditions such as temperature, vibration and electromagnetic interference and to meet all requirements that are needed in heavy duty crane operation.

Complete machine operating data are shown on a high resolution display. Standard operational information is displayed by means of graphical symbols, fault indications are displayed in plain text (more than 15 languages available).

The cranes are equipped with proportional control for all main movements, which can be carried out simultaneously.

The crane is operated with 2 multi-directional joysticks, the right for winch I and boom, the left for winch II and swing control.

Option:

Bi-directional double T-levers for simultaneous boom and luffing jib operation.

The crawlers are activated by the two central foot pedals. Additionally, hand levers can be attached to the pedals.

Remote control for assembly of counterweight and boom hinge pins.



Noise emission

Noise emissions correspond with 2000/14/EC directive on noise emission by equipment used outdoors.

Boom combinations

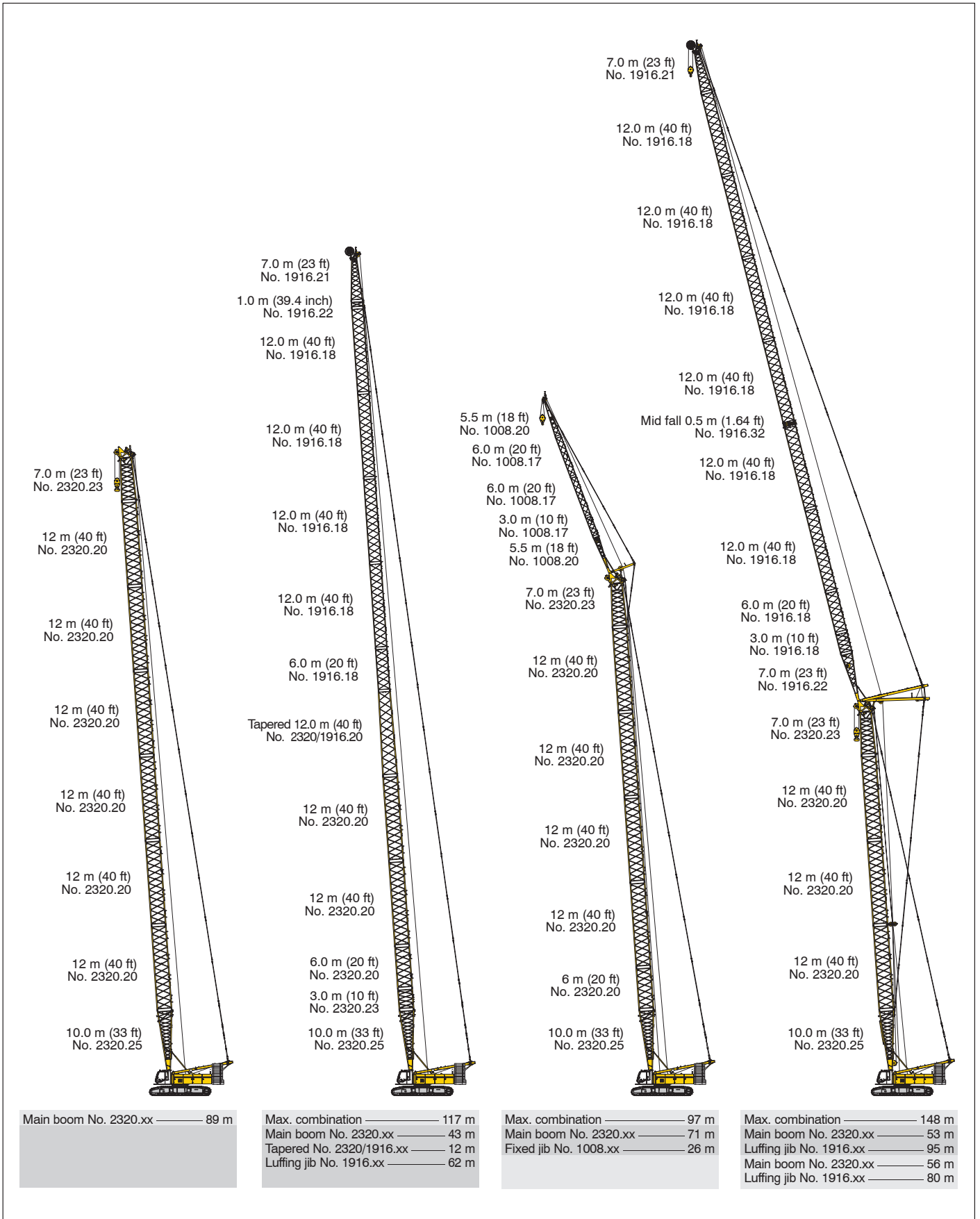

Self assembly system

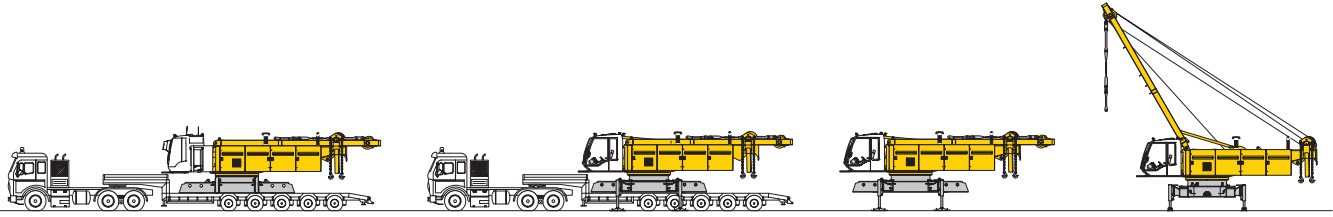

Unloading of basic machine

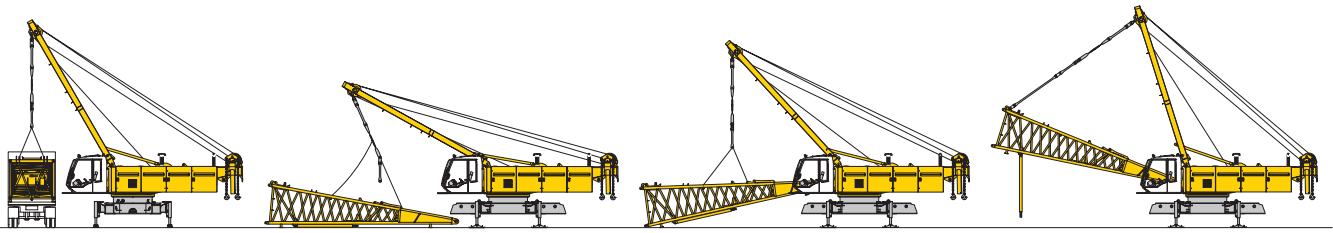

Unloading and assembly of boom foot

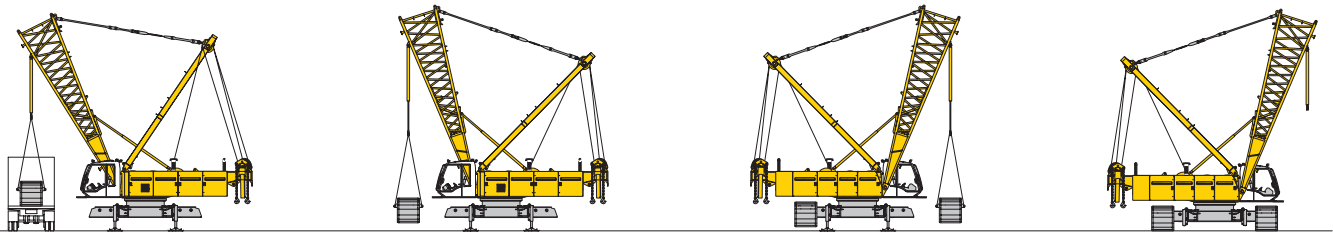

Unloading and assembly of crawlers

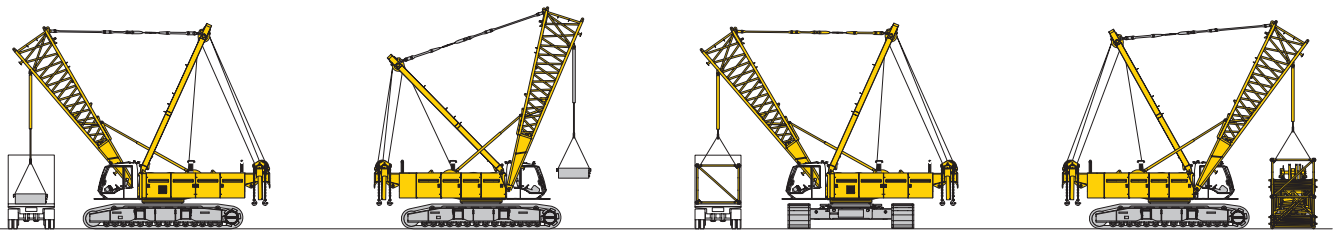

Unloading and assembly of carbody counterweight

Unloading and assembly of boom

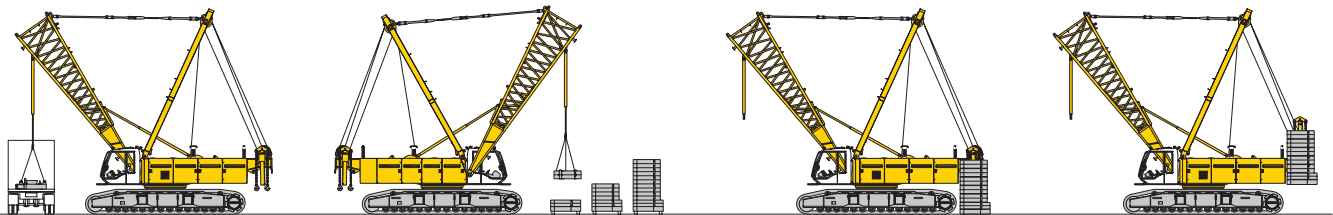

Unloading and assembly of counterweight

Erecting of main boom to working position

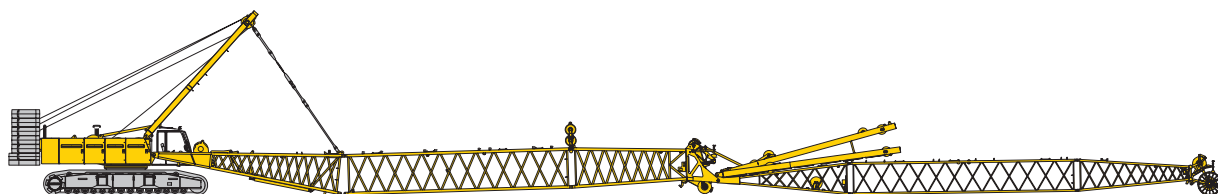

Assembly of boom

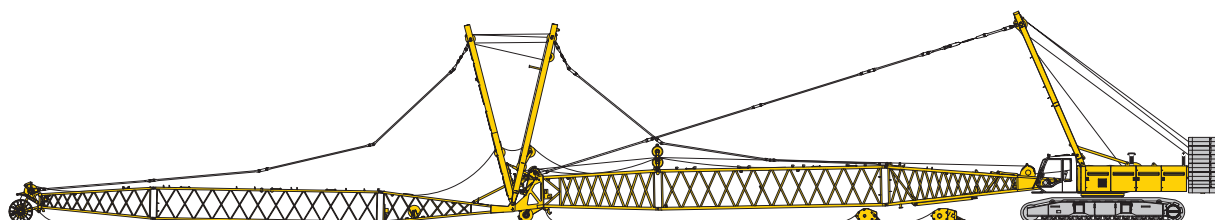

Reeving of hoist and luffing jib ropes

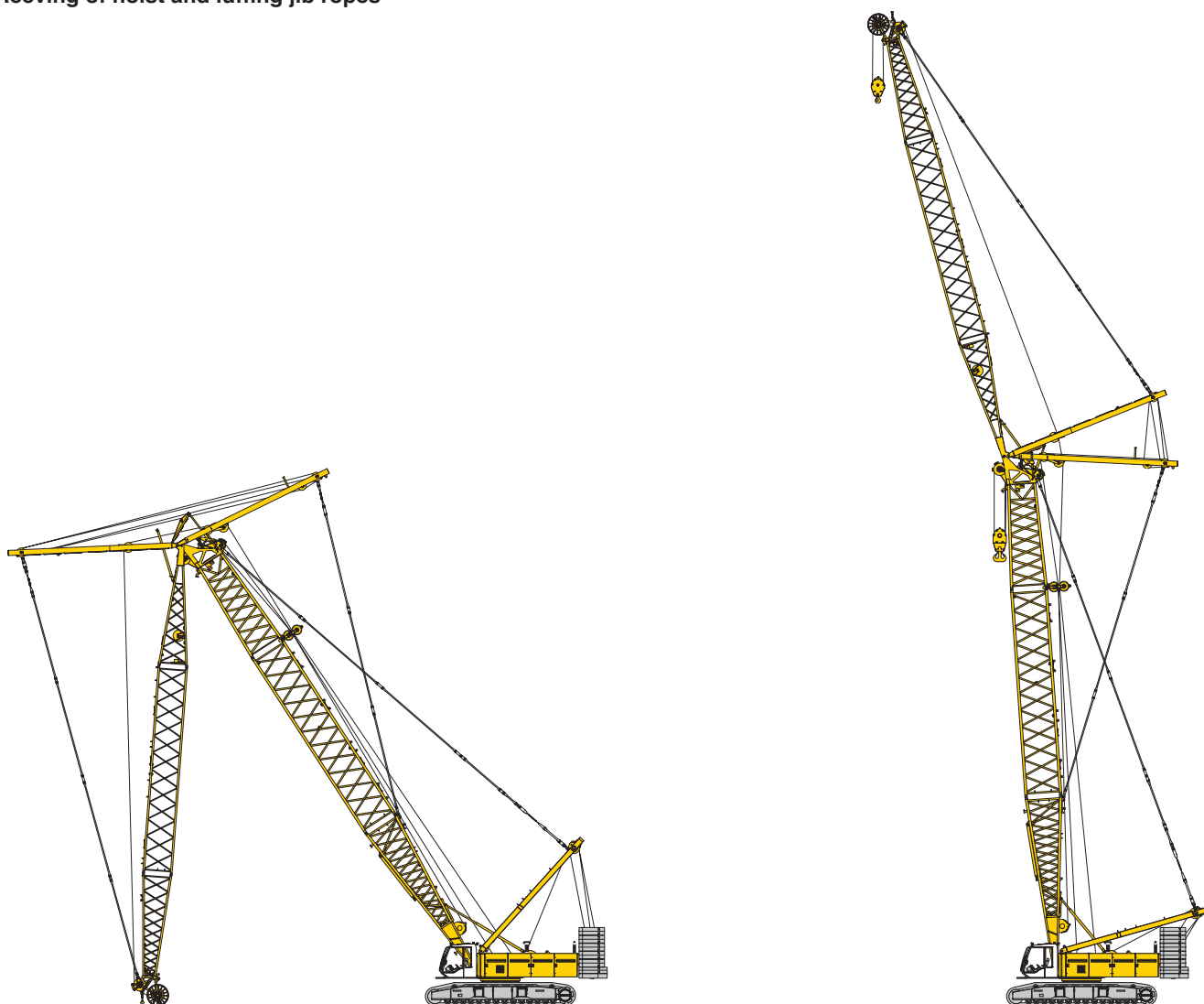

Erecting of main boom and luffing jib

Working position

Working range - main boom (No. 2320.xx) 86° - 15°

81 t counterweight and 36 t carbody counterweight

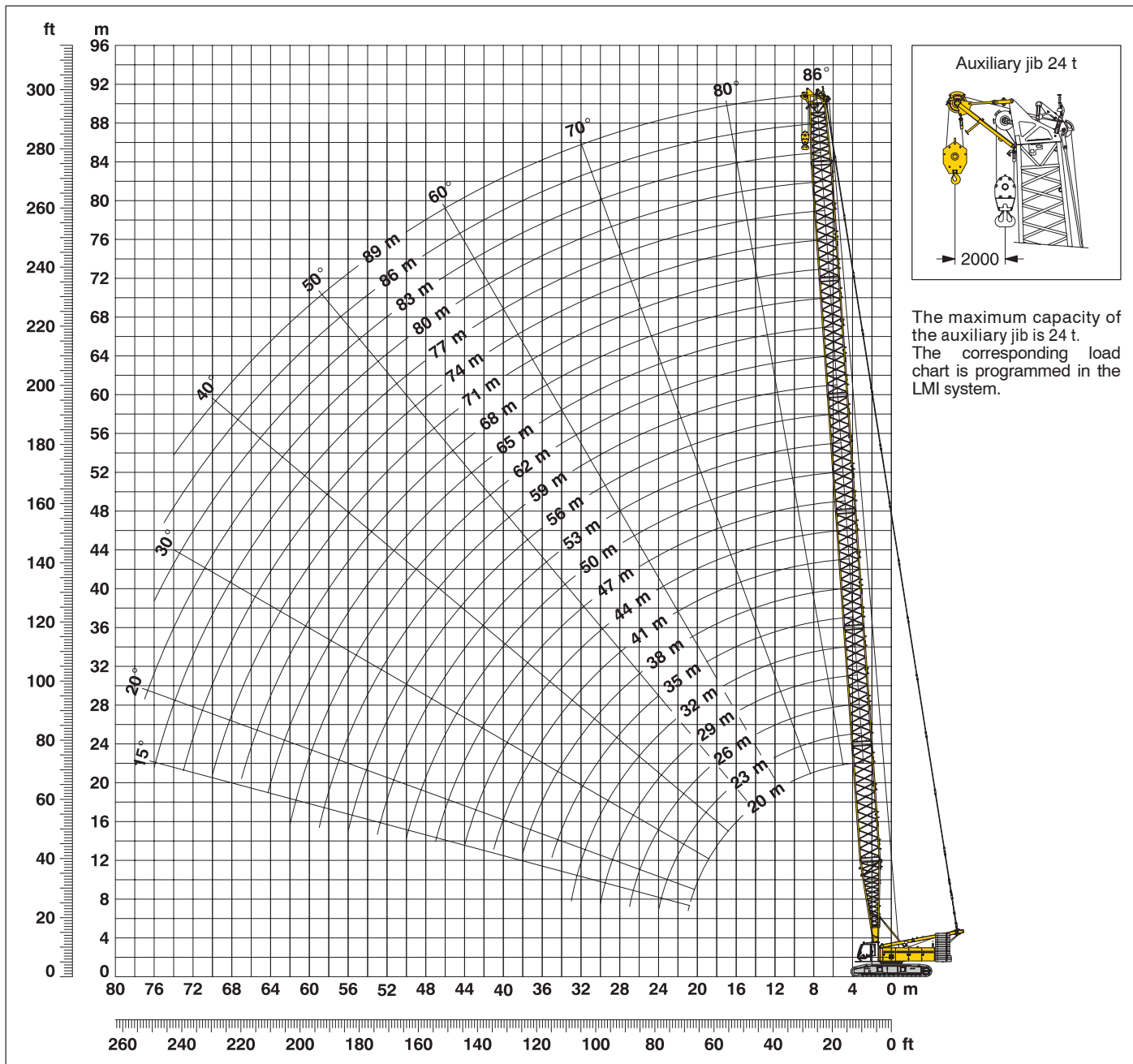

Main boom configuration (Table 1 - No. 2320.xx)

Configuration for boom lengths (20 m - 89 m)

Length	Amount of boom extensions																			
	10.0 m	3.0 m	6.0 m	12.0 m	7.0 m	10.0 m	13.0 m	16.0 m	19.0 m	22.0 m	25.0 m	28.0 m	31.0 m	34.0 m	37.0 m	40.0 m	43.0 m	46.0 m	49.0 m	52.0 m
Boom foot	1	1	1	1	1	1	1	1	1	1	1	1	1	1	1	1	1	1	1	1
Boom insert	1	1	1	1	1	1	1	1	1	1	1	1	1	1	1	1	1	1	1	1
Boom insert	1	1	1	1	1	1	1	1	1	1	1	1	1	1	1	1	1	1	1	1
Boom insert	1	1	1	1	1	1	1	1	1	1	1	1	1	1	1	1	1	1	1	1
Boom head	1	1	1	1	1	1	1	1	1	1	1	1	1	1	1	1	1	1	1	1
Boom length in (m)	20	23	26	29	32	35	38	41	44	47	50	53	56	59	62	65	68	71	74	77

Lift chart for main boom (No. 2320.xx)

81 t counterweight and 36 t carbody counterweight

Capacities in metric tons for boom lengths (20 m – 89 m) – with 120 kN winches

Radius (m)	Boom length in (m)												
	20	26	32	38	44	50	56	62	68	74	80	86	89
6.2	t	t	t	t	t	90.6	t	t	t	t	t	t	t
7				129.1	106.8	89.2	79.4	63.5					
8			125.3	117.1	99.9	83.2	75.7	62.9	51.7	44.6			
9	119.2	116.7	110.3	103.8	88.0	77.8	71.6	59.8	50.0	44.2	37.0	30.0	26.4
10	107.3	104.1	97.8	91.6	84.4	72.6	68.1	57.2	47.9	42.6	36.0	29.8	26.4
12	86.8	84.7	80.5	76.7	73.1	65.0	63.4	53.2	43.7	40.1	33.3	27.8	24.8
14	69.9	69.7	67.7	65.0	62.2	54.5	57.1	50.3	40.4	37.6	31.2	26.1	22.8
16	58.2	58.2	58.2	56.2	53.9	51.1	49.7	45.5	37.9	35.0	29.4	24.4	21.3
18	49.6	49.6	49.6	49.3	46.3	45.6	43.8	42.1	33.3	33.5	28.0	23.4	20.1
20	42.9	43.1	43.0	42.8	42.2	40.6	39.0	37.5	31.7	31.7	26.4	22.6	19.1
26		30.0	30.1	29.9	29.6	29.3	28.8	27.7	26.6	25.5	22.3	19.9	16.5
32			22.4	22.3	22.1	21.7	21.4	21.1	20.4	19.5	18.7	17.4	14.9
38				17.2	17.1	16.7	16.4	16.1	15.7	15.3	14.5	13.7	13.4
44					13.4	13.2	12.9	12.5	12.2	11.8	11.3	10.7	10.4
50						10.5	10.3	9.9	9.6	9.2	8.8	8.3	8.0
55							8.5	8.1	7.8	7.4	7.1	6.6	6.4
60								6.7	6.3	6.0	5.6	5.2	5.0
65									5.1	4.7	4.4	4.0	3.8
70										3.7	3.3	2.9	2.8
75											2.4	2.0	

Lift chart for main boom (No. 2320.xx)

70.8 t counterweight and 36 t carbody counterweight

Capacities in metric tons for boom lengths (20 m – 86 m) – with 120 kN winches

Radius (m)	Boom length in (m)													
	20	26	32	38	44	50	56	62	68	74	80	86		
4.1	220.0													
5	216.5	162.7	153.5											
6	190.7	158.9	150.6	139.9	113.7									
7	150.8	143.7	132.7	123.1	106.8	89.2	79.4	63.5						
8	132.7	122.3	114.7	107.3	99.9	83.2	75.7	62.9	51.7	44.6				
9	111.8	107.5	100.9	94.9	88.0	77.8	71.6	59.8	50.0	44.2	37.0	30.0		
10	101.3	95.2	89.9	84.9	80.4	72.6	68.1	57.2	47.9	42.6	36.0	29.8		
12	79.3	77.3	73.5	69.9	66.7	63.5	60.6	53.2	43.7	40.1	33.3	27.8		
14	63.7	63.8	62.0	59.2	56.6	54.2	51.9	49.6	40.4	37.6	31.2	26.1		
16	53.0	53.0	53.0	51.1	49.0	47.0	45.1	43.2	37.9	35.0	29.4	24.4		
18	45.1	45.1	45.1	44.8	43.0	41.3	39.7	38.0	33.3	33.5	28.0	23.4		
20	38.9	39.1	39.0	38.8	38.2	36.7	35.3	33.8	31.7	31.2	26.4	22.6		
26		27.1	27.2	26.9	26.7	26.4	25.9	24.8	23.8	22.7	21.7	19.9		
32			20.1	20.0	19.7	19.4	19.1	18.7	18.1	17.2	16.4	15.5		
38				15.3	15.1	14.8	14.5	14.1	13.8	13.3	12.5	11.8		
44					11.8	11.6	11.3	10.9	10.6	10.2	9.7	9.0		
50						9.1	8.8	8.5	8.1	7.7	7.4	6.8		
55							7.2	6.8	6.5	6.1	5.8	5.3		
60								5.5	5.2	4.8	4.4	4.0		
65									4.0	3.6	3.3	2.9		
70										2.7	2.3			

Above lift chart is for reference only. For actual lift duty please refer to lift chart in operator's cab or manual.

L – boom high reach (No.2320 / 1916.xx) **66 m - 117 m**

Working range **86° - 15°**

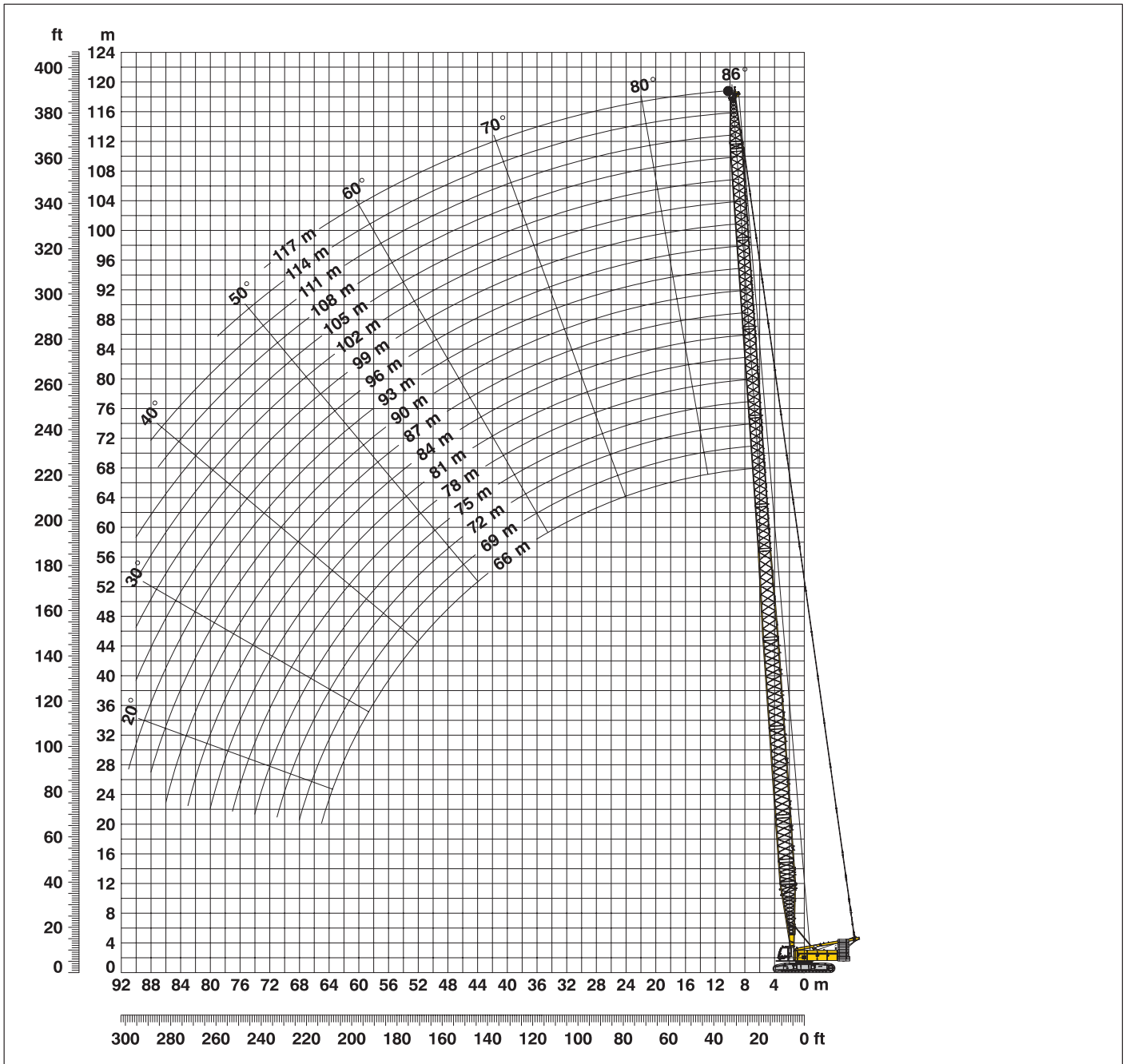

L – boom configuration with 43 m main boom (No. 2320.xx / No. 1916.xx)

Configuration for L – boom lengths (66 m – 117 m)

Configuration	Length	Amount of boom and luffing jib extensions																	
		1	1	1	1	1	1	1	1	1	1	1	1	1	1	1	1	1	1
Boom foot	10.0 m	1	1	1	1	1	1	1	1	1	1	1	1	1	1	1	1	1	1
Boom insert	3.0 m	1	1	1	1	1	1	1	1	1	1	1	1	1	1	1	1	1	1
Boom insert	6.0 m	1	1	1	1	1	1	1	1	1	1	1	1	1	1	1	1	1	1
Boom insert	12.0 m	2	2	2	2	2	2	2	2	2	2	2	2	2	2	2	2	2	2
Tapered	12.0 m	1	1	1	1	1	1	1	1	1	1	1	1	1	1	1	1	1	1
Luffing insert	3.0 m	1		1		1		1		1		1		1		1		1	
Luffing insert	6.0 m		1	1		1		1		1		1		1		1		1	
Luffing insert	12.0 m				1	1	1	1	2	2	2	2	3	3	3	3	4	4	4
Luffing jib head	8.0 m	1	1	1	1	1	1	1	1	1	1	1	1	1	1	1	1	1	1
Max. L – boom length (m)		66	69	72	75	78	81	84	87	90	93	96	99	102	105	108	111	114	117

Lift chart for L – boom (No. 2320 /1916.xx)

Main boom length 43 m

Capacities in metric tons
81 t counterweight and 36 t carbody counterweight

Radius (m)	Boom length in (m)					
	66	75	90	99	108	117
6.7	54.3					
8	53.6	39.0				
9	52.5	38.2	24.5	17.4		
10	51.6	36.7	23.4	17.3	11.6	
12	48.0	33.6	21.6	16.0	11.3	7.5
14	43.7	31.3	20.0	14.9	10.6	7.1
16	39.3	29.0	18.5	13.8	9.9	6.8
18	33.7	27.3	17.3	12.9	9.2	6.5
20	31.1	25.6	16.1	11.4	8.6	6.2
22	28.9	24.1	15.2	10.6	8.0	5.9
24	26.2	22.6	14.3	10.1	7.5	5.5
26	24.0	21.1	13.6	9.5	7.1	5.3
28	22.5	19.8	13.0	9.0	6.7	5.1
30	20.6	18.7	12.5	8.7	6.4	4.8
32	19.0	17.6	11.4	8.3	6.2	4.6
34	17.7	16.3	11.0	7.9	6.0	4.4
36	16.6	15.2	10.7	7.6	5.7	4.3
38	15.6	14.4	10.3	7.3	5.5	4.1
40	14.7	13.6	9.9	7.1	5.3	3.9
42	14.0	12.8	9.6	6.8	5.2	3.8
44	13.3	12.1	9.2	6.5	5.0	3.6
46	12.5	11.0	9.0	6.3	4.8	3.5
48	11.2	10.7	8.7	6.1	4.7	3.4
50	10.9	10.2	8.2	6.0	4.5	3.3
55	9.5	8.9	7.4	5.4	4.2	3.0
60	8.1	7.8	6.6	4.9	3.8	2.8
65	6.9	6.7	5.7	4.5	3.4	2.4
70		5.8	5.1	4.0	3.1	2.1
75			4.3	3.6	2.8	
80			3.7	3.2	2.6	
85			3.2	2.8	2.3	
90				2.4		

Main boom length 55 m

Capacities in metric tons
81 t counterweight and 36 t carbody counterweight

Radius (m)	Boom length in (m)					
	78	90	96	102	108	114
7.5	40.0					
9	39.3	27.2	22.6			
10	38.1	26.6	22.5	18.9	12.1	
12	35.1	24.8	21.2	17.9	12.1	10.7
14	32.6	22.6	20.0	16.7	12.1	10.1
16	30.5	21.3	18.7	15.6	11.9	9.7
18	28.6	20.0	17.8	14.6	11.2	9.0
20	27.0	18.9	16.7	13.8	10.7	8.5
22	25.1	18.0	15.8	12.9	10.1	8.0
24	23.2	17.1	15.2	12.3	9.5	7.5
26	22.2	16.4	14.6	11.2	9.1	7.1
28	20.1	15.9	14.1	10.6	8.6	6.8
30	18.5	15.1	13.7	10.2	8.3	6.5
32	17.2	14.4	13.2	9.9	8.0	6.3
34	15.8	13.7	12.5	9.5	7.7	6.1
36	14.6	13.2	11.2	9.1	7.4	6.0
38	13.5	12.5	11.0	8.8	7.1	5.8
40	12.7	10.9	10.7	8.5	6.9	5.6
42	11.7	10.2	9.8	8.3	6.6	5.4
44	11.1	9.6	9.1	7.8	6.5	5.3
46	10.6	9.1	8.4	7.4	6.2	5.1
48	10.1	8.6	7.9	7.0	5.9	4.9
50	9.7	8.1	7.4	6.7	5.7	4.7
55	8.2	7.2	6.5	5.9	5.2	4.2
60	6.9	6.3	5.8	5.2	4.6	3.8
65	5.9	5.3	5.0	4.7	4.0	3.4
70	5.1	4.6	4.2	4.0	3.6	3.0
75	4.3	3.9	3.6	3.3	2.9	2.6
80		3.3	3.0	2.8	2.4	
85		2.8	2.5	2.3		
90			2.0			

Above lift chart is for reference only. For actual lift duty please refer to lift chart in operator's cab or manual.

L – boom configuration with 55 m main boom (No. 2320.xx / No. 1916.xx)

Configuration for L – boom lengths (78 m – 114 m)

Length	Amount of boom and luffing jib extensions													
	10.0 m	1	1	1	1	1	1	1	1	1	1	1	1	1
Boom foot	10.0 m	1	1	1	1	1	1	1	1	1	1	1	1	1
Boom insert	3.0 m	1	1	1	1	1	1	1	1	1	1	1	1	1
Boom insert	6.0 m	1	1	1	1	1	1	1	1	1	1	1	1	1
Boom insert	12.0 m	3	3	3	3	3	3	3	3	3	3	3	3	3
Tapered	12.0 m	1	1	1	1	1	1	1	1	1	1	1	1	1
Luffing insert	3.0 m	1		1		1		1		1		1		1
Luffing insert	6.0 m		1	1			1	1			1	1		
Luffing insert	12.0 m				1	1	1	1	2	2	2	2	3	3
Luffing jib head	8.0 m	1	1	1	1	1	1	1	1	1	1	1	1	1
Max. L – boom length (m)		78	81	84	87	90	93	96	99	102	105	108	111	114

Working range - luffing jib (No. 1916.xx) 78° - 15°

Main boom 88° - 45°

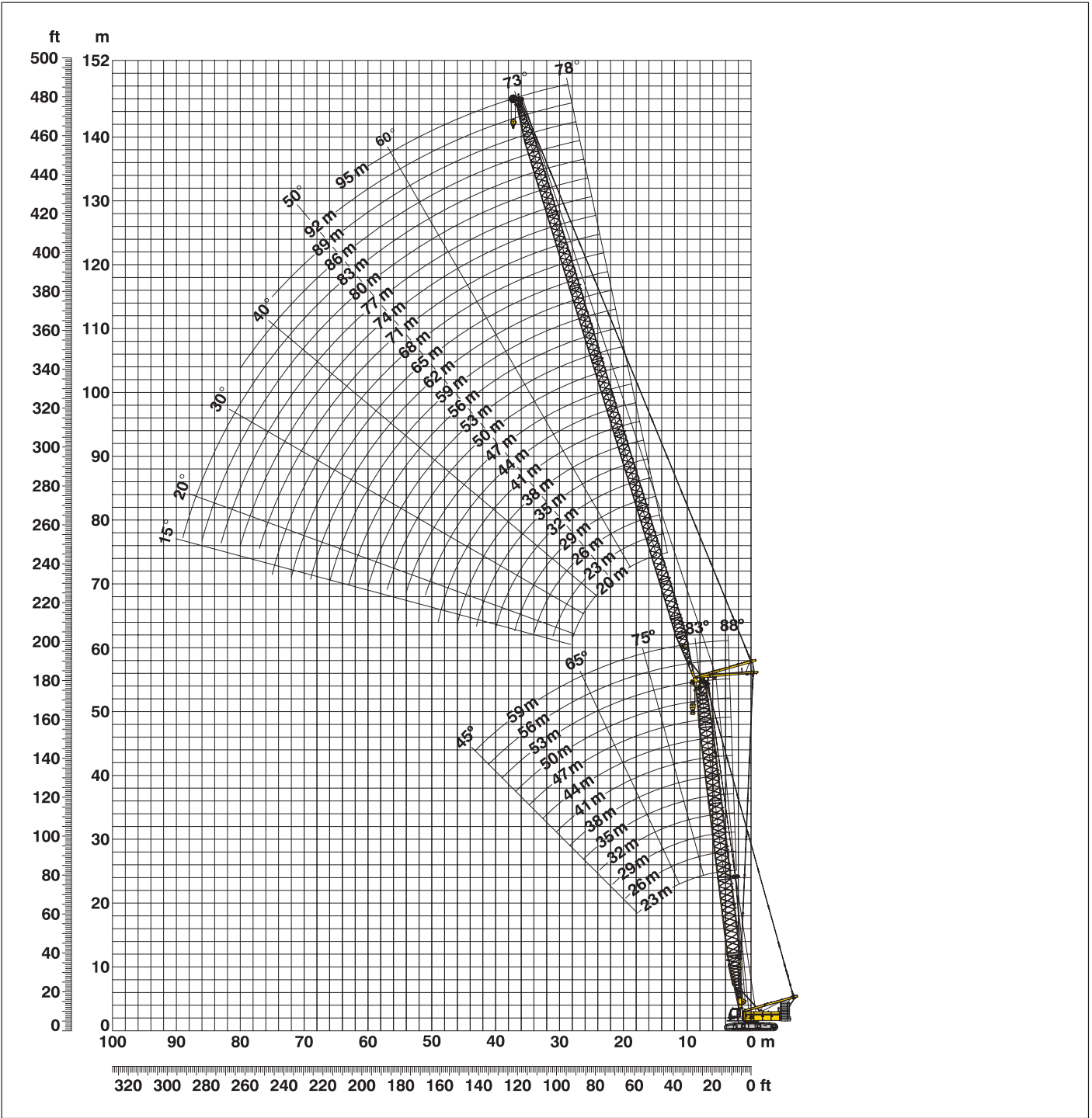

Boom configuration for main boom lengths (23 m - 59 m) – see table 1 on page 10
Jib configuration for jib lengths (20 m - 95 m)

	Length	Amount of luffing jib extensions																									
		1	2	3	4	5	6	7	8	9	10	11	12	13	14	15	16	17	18	19	20	21	22				
Luffing jib foot	7.0 m	1	1	1	1	1	1	1	1	1	1	1	1	1	1	1	1	1	1	1	1	1	1				
Luffing jib insert	3.0 m		1		1		1		1		1		1		1		1		1		1		1				
Luffing jib insert	6.0 m	1	1			1	1			1	1			1	1			1	1			1	1				
Luffing jib insert	12.0 m			1	1	1	1	2	2	2	2	3	3	3	3	4	4	4	4	5	5	5	5	6	6	6	6
Luffing jib head	7.0 m	1	1	1	1	1	1	1	1	1	1	1	1	1	1	1	1	1	1	1	1	1	1	1	1	1	1
Luffing jib length (m)		20	23	26	29	32	35	38	41	44	47	50	53	56	59	62	65	68	71	74	77	80	83	86	89	92	95

Lift chart – luffing jib (No. 1916.xx)

Main boom angle 88°

Main boom 23 m

Radius (m)	Jib length in (m)							
	20	29	41	53	62	71	83	95
9	t	t	t	t	t	t	t	t
10	63.7							
13	44.1	40.8	36.0					
15	37.8	33.7	31.7	25.5				
17	33.2	30.9	27.8	23.3	18.2			
19	29.3	27.5	24.9	21.6	17.6	12.9		
22	25.2	23.4	20.7	18.7	16.0	12.4	7.7	
24		21.3	19.3	17.2	14.9	12.1	7.5	4.7
30		17.0	15.4	13.9	12.4	10.3	7.0	4.6
42			10.7	9.5	8.6	7.5	6.0	3.8
50				7.7	6.9	6.2	5.0	3.4
55					6.1	5.4	4.5	3.0
60					5.6	4.8	3.9	2.7
65						4.4	3.4	2.5
70						3.9	3.0	2.1
75							2.7	
80							2.3	

Main boom 35 m

Radius (m)	Jib length in (m)							
	20	29	41	53	62	71	83	95
8.3	t	t	t	t	t	t	t	t
11	65.1							
13	45.7	41.7	32.7					
16	38.6	33.7	29.6	21.6				
18	33.7	31.6	27.0	20.9	15.5			
19	32.2	29.9	26.0	20.5	15.2	10.8		
22	28.5	25.8	21.9	18.8	14.7	10.5	6.7	
24		22.9	20.9	17.7	14.2	10.2	6.6	4.0
32		12.1	16.4	14.3	12.5	9.3	6.3	4.0
42			12.8	11.1	9.9	8.2	5.7	3.6
50				9.5	8.4	7.2	5.1	3.2
55				8.6	7.6	6.5	4.9	2.9
60					6.9	5.9	4.5	2.6
65						5.4	4.1	2.4
70						4.8	3.8	2.1
75							3.4	
80							3.0	

Main boom 44 m

Radius (m)	Jib length in (m)							
	20	29	41	53	62	71	83	95
8.7	t	t	t	t	t	t	t	t
11	50.1							
13	44.5	38.0						
16	40.1	34.4	26.7					
18	33.6	30.1	24.5	18.4				
20	31.3	27.9	22.3	17.6	13.3			
22	28.5	25.4	20.9	16.6	13.1	9.4		
26	26.2	22.9	19.4	15.6	12.7	9.2	5.8	
32		20.3	17.3	14.2	11.3	8.8	5.7	3.4
44		17.0	15.0	12.7	10.3	8.2	5.7	3.4
50			11.3	9.7	8.5	6.9	5.0	3.1
55				8.6	7.3	6.3	4.6	2.9
60				7.6	6.6	5.7	4.3	2.6
65					6.0	5.2	4.0	2.3
70						4.7	3.5	2.2
80						4.2	3.2	

Main boom 53 m

Radius (m)	Jib length in (m)							
	20	29	41	53	62	71	83	95
9	t	t	t	t	t	t	t	t
11	38.7							
14	34.8	29.5						
16	30.5	26.1	20.5					
18	27.9	24.0	19.3	14.8				
20	25.8	21.8	17.9	14.2	10.8			
24	22.9	20.2	16.7	13.4	10.6	7.8		
26	12.1	17.7	14.7	11.4	9.5	7.4	4.8	
32		16.8	13.9	10.9	9.1	7.2	4.8	2.8
44		15.1	12.4	9.6	8.0	6.5	4.6	2.8
50			10.0	7.7	6.5	5.3	3.9	2.4
55				7.1	5.8	4.8	3.4	2.2
60				6.5	5.3	4.5	3.2	
65					5.0	4.2	2.9	
70						3.8	2.6	
75						3.5	2.4	

Main boom 56 m

Radius (m)	Jib length in (m)							
	20	29	35	41	53	62	71	80
9.1	t	t	t	t	t	t	t	t
11	37.2							
13	34.6	28.4						
14	31.6	26.9	23.0					
16	30.4	25.7	22.5	20.0				
18	27.9	23.2	21.1	18.8	14.4			
20	26.0	21.8	19.7	17.6	13.9	10.5		
22	23.2	20.3	18.3	16.6	13.1	10.3	7.4	
24	22.4	18.9	17.3	15.5	12.4	9.7	7.3	5.3
32	12.1	17.9	16.2	14.7	11.3	9.2	7.2	5.3
38		14.9	13.6	12.5	9.7	7.9	6.4	5.1
44			12.1	10.9	8.7	7.2	5.9	4.7
55				9.7	7.7	6.6	5.3	4.3
60					6.3	5.4	4.5	3.6
70						4.9	4.0	3.3
75							3.3	2.6

Main boom 59 m

Radius (m)	Jib length in (m)							
	20	29	35	41	53	62		
9.2	t	t	t	t	t	t		
12	32.6							
13	29.4	24.6						
14	28.0	23.1	20.9					
16	26.9	22.3	20.1	17.9				
18	24.7	20.9	18.7	16.8	13.0			
20	22.7	19.4	17.5	15.7	12.5	9.3		
22	20.9	18.0	16.2	14.8	11.4	9.1		
24	19.6	16.7	15.3	13.8	10.5	8.7		
32	12.1	15.8	14.4	13.0	10.0	8.3		
38		13.7	12.2	10.7	8.4	7.0		
40			10.9	9.7	7.5	6.3		
44				9.4	7.3	6.1		
50				8.9	6.8	5.7		
55					6.2	5.1		
60					5.8	4.7		

Capacities in metric tons with luffing jib (No. 1916.xx) 81 t counterweight + 36 t carbody counterweight. Above lift chart is for reference only. For actual lift duty and complete chart with all available configurations please refer to lift chart in operator's cab or manual.

Lift chart - luffing jib (No. 1916.xx)

Main boom angle 83°

Main boom 23 m

Radius (m)	Jib length in (m)							
	20	29	41	53	62	71	83	95
11.7	57.4	t						
15	43.5	41.0						
18	35.0	32.5	29.5					
22	27.4	25.9	22.9	21.2				
24	24.9	23.4	21.1	19.2	15.9			
28		19.5	18.0	16.3	14.6	11.0		
32		17.0	15.6	14.3	13.0	10.5	7.1	
34			14.6	13.4	12.3	10.1	6.9	4.5
44			10.7	9.7	8.9	7.9	6.1	3.9
50				8.2	7.5	6.7	5.4	3.5
55				7.2	6.5	5.9	4.8	3.2
60					5.9	5.2	4.3	2.9
65					5.2	4.7	3.8	2.6
70						4.2	3.3	2.3
75							2.9	
80							2.5	
85							2.2	

Main boom 35 m

Radius (m)	Jib length in (m)							
	20	29	41	53	62	71	83	95
13.1	55.2	t						
16	44.9	41.0						
20	35.1	32.5	28.3					
24	29.2	26.9	23.0	19.3				
26	27.0	24.9	21.9	18.6	14.3			
28		22.3	20.6	17.8	14.1	10.0		
32		20.3	18.2	16.1	13.5	9.7	6.4	
34		19.2	17.2	15.3	13.1	9.6	6.4	
36			16.3	14.5	12.8	9.3	6.3	3.9
46			12.9	11.0	10.2	8.3	5.6	3.6
55				9.4	8.3	7.2	5.1	3.1
60					7.6	6.5	4.9	2.8
65					6.9	5.9	4.5	2.6
70						5.4	4.2	2.3
75						4.9	3.9	2.1
80							3.6	
85							3.2	

Main boom 44 m

Radius (m)	Jib length in (m)							
	20	29	41	53	62	71	83	95
14.2	40.6	t						
17	35.9	31.0						
22	28.6	25.6	21.1					
24	26.5	22.9	19.8	15.7				
26	25.1	22.0	18.7	15.3				
28		21.0	17.9	14.7	12.2			
30		20.0	17.1	14.2	11.4	8.8		
34		18.3	15.9	13.4	10.7	8.5	5.7	
36		12.1	15.2	12.9	10.4	8.3	5.6	
38			14.5	12.4	10.2	8.1	5.6	3.4
46			12.5	10.4	8.9	7.3	5.2	3.3
55				8.9	7.6	6.4	4.6	2.9
65					6.5	5.4	4.0	2.4
70						5.1	3.7	2.2
75						4.7	3.5	
85							2.9	

Main boom 53 m

Radius (m)	Jib length in (m)							
	20	29	41	53	62	71	83	95
15.3	31.5	t						
18	28.2	24.2						
22	24.0	20.6	17.0					
26	21.0	18.2	15.2	12.3				
28	20.1	17.4	14.6	11.3	9.3			
32		16.1	13.5	10.5	8.8	7.1		
34		15.6	13.0	10.2	8.5	6.8	4.7	
36		15.1	12.6	9.9	8.2	6.7	4.7	
38			12.2	9.5	8.0	6.4	4.7	2.8
48			10.2	8.1	6.8	5.5	4.0	2.6
55				7.3	6.1	5.0	3.5	2.2
60				6.8	5.7	4.6	3.3	
65					5.3	4.3	3.0	
75						3.7	2.5	
80							2.3	
85							2.1	

Main boom 56 m

Radius (m)	Jib length in (m)							
	20	29	35	41	53	62	71	80
15.7	31.2	t						
19	27.5	23.3						
22	24.5	20.8	18.8	16.6				
26	21.6	18.6	16.9	15.2	12.1			
28	20.8	17.8	16.2	14.6	11.2	9.1		
32		16.4	15.0	13.6	10.5	8.7	6.9	
34		15.9	14.4	13.2	10.2	8.5	6.7	5.1
36		15.3	13.9	12.8	9.9	8.2	6.6	5.1
42			12.6	11.2	9.0	7.5	6.0	4.8
48				10.2	8.2	6.9	5.5	4.5
60					6.7	5.8	4.7	3.7
65						5.4	4.4	3.4
70							4.1	3.2
75							3.8	3.0
80								2.7
85								2.4

Main boom 59 m

Radius (m)	Jib length in (m)							
	20	29	35	41	53	62		
16	27.1	t						
19	24.2	20.5						
22	21.1	18.4	16.8					
24	19.9	17.3	15.7	14.2				
26	18.8	16.3	14.9	13.6	10.2			
28	18.2	15.6	14.3	13.0	10.0			
30		15.0	13.7	12.6	9.6	8.0		
38		12.1	11.5	10.5	8.4	6.9		
42			11.0	9.8	7.8	6.5		
46				9.3	7.3	6.1		
48				9.0	7.0	5.9		
50					6.8	5.8		
55					6.4	5.3		
60					6.0	4.9		
65						4.6		
70						4.3		

Capacities in metric tons with luffing jib (No. 1916.xx) 81 t counterweight + 36 t carbody counterweight. Above lift chart is for reference only. For actual lift duty and complete chart with all available configurations please refer to lift chart in operator's cab or manual.

Lift chart – luffing jib (No. 1916.xx)

Main boom angle 75°

Main boom 23 m

Radius (m)	Jib length in (m)							
	20	29	41	53	62	71	83	95
17.5	t	t	t	t	t	t	t	t
22	44.8							
28	32.6	31.4						
32	12.1	22.7	21.4					
36		19.2	18.0	16.9				
40		16.6	15.6	14.6	13.6			
46			13.6	12.8	11.6	9.8		
48			11.0	10.4	9.7	8.9	6.1	
50			10.5	9.7	9.1	8.3	6.0	
55				9.2	8.6	7.8	5.8	3.7
60				8.0	7.4	6.8	5.4	3.4
65				6.9	6.5	5.9	5.0	3.1
70					5.8	5.2	4.5	2.8
75						4.6	3.9	2.6
80						4.1	3.4	2.3
85							3.0	
85							2.5	

Main boom 35 m

Radius (m)	Jib length in (m)							
	20	29	41	53	62	71	83	95
20.6	t	t	t	t	t	t	t	t
26	38.0							
30	30.3	28.7						
36	25.8	24.9	23.2					
40		20.4	19.3	17.4				
44		12.1	17.2	15.8	13.1			
48			15.3	14.1	12.7	9.0		
50			13.7	12.9	11.3	8.7	5.7	
55			12.9	12.3	10.9	8.5	5.6	
60				10.7	9.8	8.1	5.4	3.3
65				9.6	8.7	7.6	5.1	3.1
70					7.9	6.9	4.9	2.8
75					7.1	6.3	4.7	2.6
80						5.7	4.4	2.4
85						5.2	4.2	2.1
90							3.8	
90							3.5	

Main boom 44 m

Radius (m)	Jib length in (m)							
	20	29	41	53	62	71	83	95
22.9	t	t	t	t	t	t	t	t
28	29.3							
32	25.3	22.6						
38	22.5	20.5	17.6					
42		17.8	15.8	13.5				
46		15.9	14.7	12.8	10.2			
48			13.4	11.4	9.7	7.6		
50			12.8	11.1	9.5	7.5		
55			12.2	10.8	9.2	7.4	5.0	
60				9.8	8.6	7.0	4.9	2.9
65				8.9	7.9	6.6	4.7	2.8
70				8.0	7.3	6.1	4.4	2.7
75					6.6	5.7	4.1	2.4
80						5.2	3.9	2.2
85						4.7	3.6	
90							3.3	
90							2.9	

Main boom 53 m

Radius (m)	Jib length in (m)							
	20	29	41	53	62	71	83	95
25.2	t	t	t	t	t	t	t	t
30	23.0							
32	21.0	18.2						
36	20.2	17.5						
40	12.1	16.1	13.6					
44		14.9	12.7	9.9				
48		13.9	11.5	9.4	7.8			
50			10.7	8.8	7.4	5.9		
55			10.4	8.6	7.2	5.8		
60			9.8	7.9	6.7	5.5	3.9	
65				7.4	6.3	5.1	3.7	2.2
70				7.1	5.8	4.8	3.4	2.0
75					5.5	4.4	3.1	
80					5.1	4.1	2.9	
85						3.9	2.6	
90						3.4	2.5	
90							2.1	

Main boom 56 m

Radius (m)	Jib length in (m)							
	20	29	35	41	53	62	71	80
26	t	t	t	t	t	t	t	t
30	23.1							
34	21.0	18.5						
36	18.6	17.2	15.7					
40	17.5	16.5	15.1	13.7				
44		14.8	14.1	13.0	9.8			
48		13.3	12.7	12.2	9.5	7.7		
50			11.6	11.0	9.0	7.5	5.7	
55			11.0	10.5	8.8	7.3	5.7	
65				9.4	8.2	6.9	5.6	4.3
75					6.7	6.0	4.9	3.8
85						4.8	4.1	3.4
90							3.1	2.5
90								2.1

Main boom 59 m

Radius (m)	Jib length in (m)						
	20	29	35	41	53	62	
26.8	t	t	t	t	t	t	
32	20.4						
34	18.4	15.8					
36	17.7	15.2	13.8				
42	16.9	14.7	13.4	11.4			
46		13.4	12.2	10.5	8.4		
48		12.1	11.1	10.0	7.9	6.5	
50			10.8	9.7	7.7	6.4	
55			10.6	9.4	7.5	6.2	
60				8.9	7.0	5.8	
65					6.6	5.5	
70					6.2	5.1	
75						4.9	
75						4.5	

Capacities in metric tons with luffing jib (No. 1916.xx) 81 t counterweight + 36 t carbody counterweight. Above lift chart is for reference only. For actual lift duty and complete chart with all available configurations please refer to lift chart in operator's cab or manual.

Lift chart - luffing jib (No. 1916.xx)

Main boom angle 65°

Main boom 23 m

Radius (m)	Jib length in (m)							
	20	29	41	53	62	71	83	95
24.3	33.3	t	t	t	t	t	t	t
30	25.6	25.3						
32	12.1	22.9						
38		18.0	17.4					
40		16.5	16.0					
44			13.9	13.5				
46			13.0	12.6				
50			11.1	10.8	10.2			
55				9.1	8.8	7.6		
60				7.9	7.5	6.9		
65					6.5	6.0	4.9	
70					5.7	5.2	4.6	2.7
75						4.7	4.0	2.5
80						4.1	3.5	2.3
90							2.6	

Main boom 35 m

Radius (m)	Jib length in (m)							
	20	29	41	53	62	71	83	95
29.3	24.2	t	t	t	t	t	t	t
36	18.7	18.3						
42		15.0	14.4					
44		14.1	13.6					
48			12.1					
50			11.5	10.7				
55			10.0	9.5	8.8			
60				8.3	7.8	7.0		
65				7.3	6.9	6.2		
70					6.1	5.4	4.5	
75					5.4	4.8	3.9	2.6
80						4.3	3.4	2.3
85						3.7	2.9	2.1
90							2.5	
95							2.1	

Main boom 44 m

Radius (m)	Jib length in (m)						
	20	29	41	53	62	71	83
33.1	18.7	t	t	t	t	t	t
40	15.0	14.3					
46		12.1	11.1				
48		11.5	10.5				
55			8.9	7.9			
60			7.9	7.0	6.3		
65				6.2	5.6	4.8	
70				5.6	4.9	4.1	3.2
75					4.4	3.6	2.7
80					3.9	3.1	2.2
85						2.7	
90						2.3	

Main boom 53 m

Radius (m)	Jib length in (m)					
	20	29	41	53	62	71
36.9	14.2	t	t	t	t	t
44	11.7	10.8				
46		10.3				
48		9.8				
50		9.3	8.2			
55			7.3			
60			6.4	5.4		
65			5.7	4.8	4.1	
70				4.2	3.6	2.8
75				3.7	3.1	2.3
80					2.7	
85					2.3	

Main boom 56 m

Radius (m)	Jib length in (m)						
	20	29	35	41	53	62	71
38.2	12.9	t	t	t	t	t	t
44	11.0	10.1					
46	10.4	9.6					
48		9.1	8.5				
50		8.6	8.1				
55			7.1	6.7			
60			6.3	5.9	4.9		
65				5.2	4.3	3.6	
70					3.7	3.1	2.3
75					3.3	2.6	
80						2.2	

Main boom 59 m

Radius (m)	Jib length in (m)					
	20	29	35	41	53	62
39.5	11.5	t	t	t	t	t
42	10.8					
44	10.3					
46	9.7	8.9				
48		8.4				
50		8.0	7.4			
55		7.1	6.6	6.1		
60			5.8	5.4	4.4	
65				4.7	3.8	3.1
70					3.3	2.6
75					2.8	2.2

Capacities in metric tons with luffing jib (No. 1916.xx) 81 t counterweight + 36 t carbody counterweight. Above lift chart is for reference only. For actual lift duty and complete chart with all available configurations please refer to lift chart in operator's cab or manual.

Lift chart – luffing jib (No. 1916.xx)

Main boom angle 45°

Main boom 23 m

Radius (m)	Jib length in (m)						
	20	29	41	53	62	71	83
t	t	t	t	t	t	t	t
35.6	18.7						
38	17.1						
44		13.9					
46		13.1					
55			9.8				
65				7.1			
70				6.3	5.8		
75					5.2		
80						4.1	
85						3.5	
90							2.5
95							2.1

Main boom 35 m

Radius (m)	Jib length in (m)				
	20	29	41	53	62
t	t	t	t	t	t
44.1	11.7				
46	11.1				
55		8.3			
65			5.9		
75				4.0	
80					3.0
85					2.6

Main boom 44 m

Radius (m)	Jib length in (m)			
	20	29	41	53
t	t	t	t	t
50.4	7.9			
60		5.7		
70			3.7	
80				2.0

Main boom 53 m

Radius (m)	Jib length in (m)		
	20	29	
t	t	t	
56.8	4.9		
65		3.2	

Main boom 56 m

Radius (m)	Jib length in (m)		
	20	29	
t	t	t	
58.9	3.8		
60	3.7		
70		2.1	

Main boom 59 m

Radius (m)	Jib length in (m)		
	20		
t	t		
61	2.9		

Capacities in metric tons with luffing jib (No. 1916.xx) 81 t counterweight + 36 t carbody counterweight. Above lift chart is for reference only. For actual lift duty and complete chart with all available configurations please refer to lift chart in operator's cab or manual.

Working range - fixed jib (No. 1008.xx) 15° and 30°

Main boom 88° - 30°

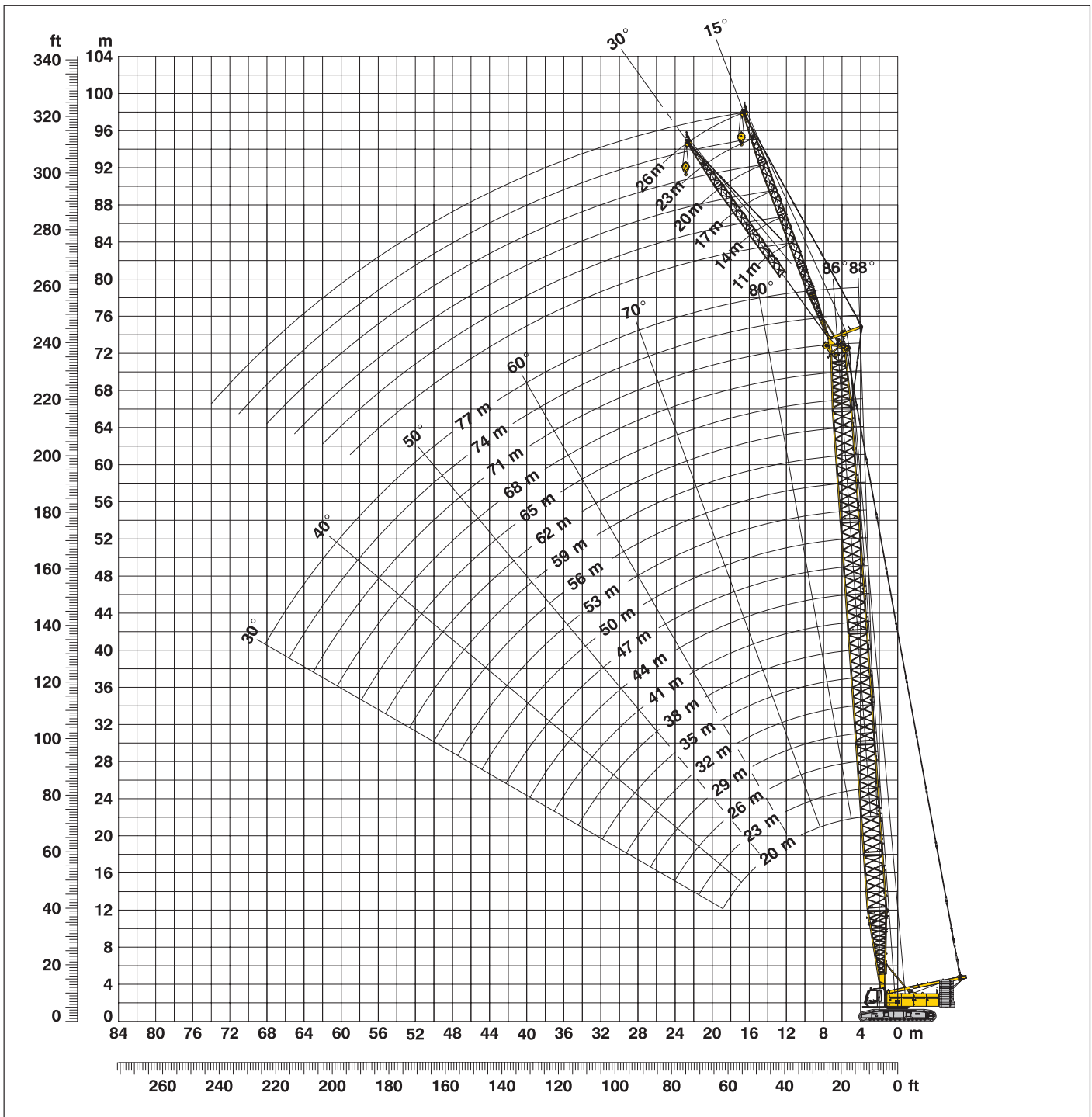

Boom configuration for boom lengths (20 m - 77 m) – see table 1 on page 10
Fixed jib configuration for fixed jib lengths (11 m - 26 m)

	Length	Amount of fixed jib extensions					
Fixed jib foot	5.5 m	1	1	1	1	1	1
Fixed jib insert	3.0 m		1		1		1
Fixed jib insert	6.0 m			1	1	2	2
Fixed jib head	5.5 m	1	1	1	1	1	1
Fixed jib length (m)		11	14	17	20	23	26

Lift chart – fixed jib (No. 1008.xx)

Offset 15°

Main boom 20 m

Radius (m)	Fixed jib length in (m)			
	11	14	20	26
9	t	t	t	t
10	35.9	34.1		
11	35.9	33.3	27.4	
12	35.9	32.6	26.3	19.2
16	35.1	29.8	22.5	16.7
20	32.8	26.5	19.7	14.8
24	27.5	22.6	16.8	13.2
28	24.0	20.5	14.6	11.3
30	23.0	19.3	13.7	10.9
32		18.2	12.9	10.5
38			11.3	8.7
44				7.6

Main boom 29 m

Radius (m)	Fixed jib length in (m)			
	11	14	20	26
8	t	t	t	t
9	35.9	34.9		
10	35.9	34.2	28.3	
12	35.9	33.0	26.4	18.9
20	34.7	29.2	20.7	15.1
26	30.5	25.2	17.7	13.3
30	25.0	22.1	15.7	12.1
36	19.2	19.5	13.4	10.6
38	17.7	18.0	12.8	10.1
40		16.7	12.3	9.5
46			11.2	8.3
50				7.7

Main boom 38 m

Radius (m)	Fixed jib length in (m)			
	11	14	20	26
7	t	t	t	t
8	35.9	35.4		
10	35.9	34.3	28.1	
13	35.9	33.0	25.9	18.1
20	35.9	30.6	21.5	15.1
30	24.4	24.7	17.5	12.9
40	15.8	16.1	14.0	10.6
44	13.5	13.8	12.9	9.7
46	12.1	12.7	12.5	9.3
48		11.9	12.1	8.9
55			9.7	8.0
60				7.4

Main boom 47 m

Radius (m)	Fixed jib length in (m)			
	11	14	20	26
6.6	t	t	t	t
8	35.9	34.4		
11	35.9	33.2	26.2	
13	35.9	32.4	24.9	17.6
18	35.6	30.8	21.7	15.7
20	34.9	30.0	20.8	15.1
30	23.8	24.2	18.2	13.1
40	15.2	15.5	15.1	11.1
50	10.3	10.5	11.0	9.5
55		8.7	9.2	8.7
60			7.6	8.0
65				6.7

Main boom 56 m

Radius (m)	Fixed jib length in (m)			
	11	14	20	26
6.9	t	t	t	t
9	35.9	33.5		
11	35.9	32.7	25.1	
13	35.9	32.1	24.2	16.6
20	32.5	28.7	20.6	14.6
30	22.6	22.7	17.9	12.9
40	14.6	14.9	15.3	11.4
50	9.7	9.9	10.4	10.3
60	6.4	6.6	7.1	7.5
65			5.8	6.1
70			4.6	5.0
75				4.0

Main boom 62 m

Radius (m)	Fixed jib length in (m)			
	11	14	20	26
7.1	t	t	t	t
9	35.8	32.6		
11	35.2	31.7	23.2	
13	33.8	30.5	22.6	15.9
20	27.7	25.8	19.8	14.2
30	21.6	21.0	17.0	12.7
40	14.2	14.4	14.7	11.3
50	9.3	9.5	10.0	10.2
60	6.0	6.2	6.7	7.1
65	4.7	4.9	5.4	5.7
75			3.3	3.6
80				2.7

Main boom 68 m

Radius (m)	Fixed jib length in (m)			
	11	14	20	26
7.3	t	t	t	t
9	34.1	30.2		
11	31.8	29.2	21.7	
14	28.3	26.7	20.8	15.1
20	21.9	21.7	18.4	13.7
30	18.4	17.8	15.4	12.3
40	13.5	13.6	13.8	10.8
50	8.9	9.1	9.5	9.6
60	5.6	5.8	6.3	6.7
70	3.3	3.5	3.9	4.2
75		2.5	2.9	3.3
80			2.0	2.4

Main boom 74 m

Radius (m)	Fixed jib length in (m)			
	11	14	17	20
7.5	t	t	t	t
9	29.0	26.1		
10	27.8	26.1	22.8	
12	26.1	24.6	22.4	19.7
20	19.2	18.6	17.7	16.4
30	15.7	15.1	14.4	13.8
40	12.7	12.8	13.0	12.5
50	8.3	8.5	8.7	8.8
60	5.2	5.4	5.6	5.8
65	3.9	4.1	4.4	4.5
70	2.8	3.0	3.3	3.5
75		2.1	2.3	2.5

Main boom 77 m

Radius (m)	Fixed jib length in (m)			
	11	14		
7.6	t	t		
9	26.7	23.3		
10	25.8	23.3		
18	19.1	18.2		
20	17.9	17.1		
30	14.6	14.0		
40	12.3	12.4		
50	8.0	8.2		
55	6.4	6.5		
60	5.0	5.1		
65	3.7	3.9		
70	2.7	2.9		

Capacities in metric tons with fixed jib (No. 1008.xx) 81 t counterweight + 36 t carbody counterweight. Above lift chart is for reference only. For actual lift duty and complete chart with all available configurations please refer to lift chart in operator's cab or manual.

Lift chart - fixed jib (No. 1008.xx)

Offset 30°

Main boom 20 m

Radius (m)	Fixed jib length in (m)			
	11	14	20	26
11	t	t	t	t
13	34.7			
15	31.1	26.1		
18	28.3	23.8	16.9	
20	25.1	21.4	14.9	12.1
24	23.3	19.9	13.9	11.3
28	21.3	17.5	12.2	9.7
30	19.5	15.8	11.1	8.5
32	18.9	15.2	10.7	8.0
34		14.8	10.2	7.6
40		12.1	9.7	7.2
46			9.0	6.3
46				6.0

Main boom 29 m

Radius (m)	Fixed jib length in (m)			
	11	14	20	26
10	t	t	t	t
12	35.9			
15	34.6	27.7		
18	30.6	25.0	17.1	
20	27.5	23.2	15.5	12.1
24	26.0	21.6	14.5	11.6
28	23.2	19.3	13.0	10.2
30	21.8	17.5	12.0	9.1
38	20.9	16.8	11.5	8.6
40	17.8	14.9	10.0	7.1
46		14.6	9.7	6.9
46			9.1	6.3
50				6.1

Main boom 38 m

Radius (m)	Fixed jib length in (m)			
	11	14	20	26
8.9	t	t	t	t
11	35.9			
15	35.7	29.0		
19	32.2	26.6	17.8	
20	28.6	24.0	15.8	12.1
24	27.8	23.9	15.4	11.7
30	25.3	21.4	14.0	10.5
40	22.9	18.8	12.3	9.1
46	16.0	16.0	10.7	7.4
48	12.5	12.9	9.8	6.7
55			9.3	6.1
60				6.0

Main boom 47 m

Radius (m)	Fixed jib length in (m)			
	11	14	20	26
9.2	t	t	t	t
12	35.9			
15	35.6	28.0		
19	33.6	26.4	17.3	
20	30.1	23.5	15.7	12.0
24	29.5	23.4	15.4	11.8
30	26.8	21.9	14.1	10.7
40	23.4	19.5	12.6	9.4
50	15.5	15.9	11.1	7.9
55	10.4	10.7	9.8	6.8
60		8.8	9.3	6.4
65			7.8	6.1
65				6.0

Main boom 56 m

Radius (m)	Fixed jib length in (m)			
	11	14	20	26
9.5	t	t	t	t
12	35.5			
16	34.6	28.1		
19	31.9	26.0	17.4	
20	29.6	24.6	16.3	11.8
30	28.9	24.0	15.9	11.8
40	23.2	20.0	13.3	9.6
50	15.0	15.4	11.7	8.1
60	9.9	10.2	10.5	7.1
65	6.5	6.8	7.3	6.4
70		5.4	6.0	6.2
75			4.7	5.2
75				4.1

Main boom 62 m

Radius (m)	Fixed jib length in (m)			
	11	14	20	26
9.8	t	t	t	t
12	33.1			
16	32.4	26.8		
20	29.6	25.1	17.2	
30	26.6	23.0	16.0	11.7
40	21.8	18.8	13.6	9.7
50	14.6	14.9	12.0	8.3
60	9.5	9.9	10.5	7.3
65	6.1	6.4	7.0	6.6
70	4.8	5.1	5.6	6.1
75		3.9	4.4	4.9
80			3.4	3.8
80				2.9

Main boom 68 m

Radius (m)	Fixed jib length in (m)			
	11	14	20	26
10	t	t	t	t
12	30.2			
16	29.7	25.2		
20	26.4	23.5	16.8	
30	22.6	21.1	15.9	11.5
40	18.6	17.0	13.4	9.8
50	13.9	14.2	11.7	8.5
60	9.2	9.5	10.1	7.5
65	5.8	6.1	6.7	6.7
70	4.5	4.7	5.3	5.8
75	3.3	3.6	4.1	4.6
80		2.6	3.1	3.5
80			2.1	2.6

Main boom 74 m

Radius (m)	Fixed jib length in (m)			
	11	14	17	20
10.2	t	t	t	t
12	26.3			
14	26.2	22.3		
16	24.3	22.2	18.9	
20	22.1	20.8	18.8	16.1
30	19.6	18.4	16.9	15.3
40	15.7	15.0	14.1	12.8
50	13.2	13.4	12.7	11.1
60	8.7	8.9	9.2	9.4
65	5.4	5.7	6.0	6.2
70	4.1	4.4	4.7	4.9
75	3.0	3.2	3.5	3.8
75		2.2	2.5	2.7

Main boom 77 m

Radius (m)	Fixed jib length in (m)			
	11	14		
10.3	t	t		
13	24.2			
16	22.7	20.6		
20	20.5	19.2		
30	18.2	17.0		
40	14.7	14.0		
50	12.8	12.8		
55	8.4	8.6		
60	6.7	6.9		
65	5.2	5.5		
70	3.9	4.2		
75	2.8	3.1		
75		2.1		

Capacities in metric tons with fixed jib (No. 1008.xx) 81 t counterweight + 36 t carbody counterweight. Above lift chart is for reference only. For actual lift duty and complete chart with all available configurations please refer to lift chart in operator's cab or manual.

Notice

